



Annual report – the sea trout project

Kirstin Eliassen, Unn V. Johannesen, Símeon Petersen, Eirikur
Danielsen and Kim S. G. Bergkvist

February 28th 2023

Fiskaaling rit 2023-02

Fiskaaling P/F
Við Áir, FO-430 Hvalvík, Føroyar (Faroe Islands)
Tlf (phone) (+298) 474747, Fax (+298) 474748, Fiskaaling@fiskaaling.fo
www.fiskaaling.fo



 Aquaculture Research Station of the Faroes Fiskaaling P/F Við Áir 11 FO-430 Hvalvík Føroyar (Faroe Islands) Tlf (phone) (+298) 474747 Fax (+298) 474748 Fiskaaling@fiskaaling.fo www.fiskaaling.fo		Frágreiðing
		Heiti Annual report – the sea trout project
		Høvundar Kirstin Eliassen, Unn V. Johannesen, Símeon Petersen, Eirikur Danielsen and Kim S. G. Bergkvist
Status	Frágreiðing nr.	Slag av verkætlan
Opin	2023-02	Uppgáva fyri Havbúnaðarfelagið
Dato		Ábyrgdarhavi
28.02.23		Kirstin Eliassen
Tal av síðum		Góðkent
24		
Samandráttur Eftir áheitan frá Havbúnaðarfelagnum eru kanningar av sjósílum framdar við tí fyri eygað at kanna nær á árinum tey fara á sjógv á fyrsta sinni og hvussu trivnaðurin hjá teimum er á sjónum. Úrslitini frá 2019-2022 vísa, at munur er millum árinum viðvíkjandi nær tey fara á sjógv á fyrsta sinni, umframt at aldurin á sjósílnum tá ið tey fara á sjógv fyrstu fer, áhaldandi sæst aftur í stóddini hjá teimum. Munur er millum árinum viðvíkjandi hvussu væl sílini eru fyri tá ið tey fara á sjógv og hvussu væl størri sílini á sjónum eru fyri. Sjósílini hava flest lýs frá apríl til august, meðan tey hinar mánaðirnar hava fáar ella ongar lýs. Hetta gevur ábendingar um at sílini avlúsa seg í feskum vatni.		
Fyrivarni <i>Tilfar og upplýsingar í hesi frágreiðing eru eftirkannað og góðskukannað við teimum avmarkingum, sum henda verkætlan ásetir. Upphavsfólk til tilfarið og upplýsingarnar ella umboð teirra eiga ikki at ábyrgjast nakrar niðurstøður og avgerðir, ið eru grundaðar á tilfarið og upplýsingarnar. Tilfar úr hesari frágreiðing kann bert endurgevast, um upprunin verður greitt tilskilaður.</i>		
Leitorð Sjósíl, longd, vekt, aldur, vøkstur, magainnihald		



The sea trout project

The aim of the project is 1) to gain knowledge on when and under what circumstances the juvenile sea trout migrate to sea, and 2) to examine annual variations in the condition of adult sea trout at sea.

Project 1: Smolt migration to sea

Material and methods

A trap (Figure 1) was mounted in the river Sandá (61.999N, 6.781W). The trap has the height of 50 cm, covers the total width of the river, and leads the seaward migrating trout into a sampling box. The trap was visited daily, where the sea trout caught were sampled, the water temperature measured, and the trap cleansed to avoid clogging. After sedation with Benzocaine (Tjaldurs Apotek, Tórshavn), the sampled sea trout were weighed to the nearest 0.1 g and length measured to the nearest 0.1 cm. Scale was sampled and stored for potential later age and growth determination, however, if the number of sea trout was high, scale was only sampled from a subsample, i.e., ~20 trout. After full recovery from the anaesthetics, the sea trout were released downstream. Sampling was terminated and the trap demounted after the first occasion of high precipitation and low numbers of sampled smolts, or when the trap was estimated to disturb the upstream migration of returning sea trout too much.

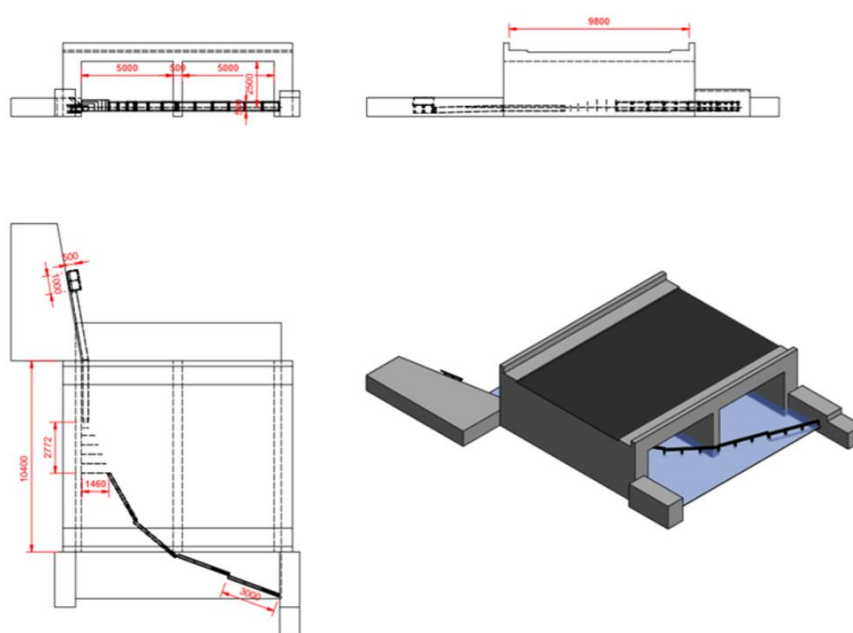

Figure 1. The sea trout trap in Sandá.



Results

The trap was mounted in the river Sandá on the 21st of April 2022, i.e., approximately at the same time as in 2020 and 2021, and 9 days later than in 2019. Due to the occurrence of the heaviest rainfall since the onset of the Sea Trout Project, which damaged the trap severely, the trap was already demounted on June 20th 2022, i.e., a month earlier than in 2020 and 2021, and 18 days earlier than in 2019.

575 sea trout entered the trap in 2022, which was less than in 2019 (675 specimens) and 2020 (616 specimens), but considerably more than in 2021 (241 specimens) (Figure 2). As in previous years, there were periods in 2022 (8 hours on May 5th) when the precipitation levels led to a rise in water levels too high for the trap, and sea trout might thus have escaped sampling. As in 2021, and unlike in 2020 and 2019, the sampling in 2022 was disturbed by youngsters catching trout hesitating to enter the trap.

If we, like previous years, make a rough estimate, based on the experience of others, i.e., www.gov.scot, and divide the sea trout sampled into categories of small (< 20.1 cm, likely juvenile) and large (> 20 cm, likely not juvenile), the trend in 2022 was approximately the same as in previous years, i.e., the large specimens dominate the early samplings, while the small specimens dominate the late samplings (Figure 2).

Like previous years, the seaward migration of sea trout in 2022 was observed to occur concurrent with occasions of precipitation (Figure 2). The window when 25% to 75% of the small sea trout (< 20.1 cm) had migrated to sea ranged in 2022 from the 9th to the 21st of May, which is the earliest recorded to date (Table 1).

Table 1. Dates when 25% and 75% of the small sea trout (< 20.1 cm) had migrated to sea in the period 2019-2022.

Year	Date of 25% migration	Date of 75% migration
2019	19.05	29.05
2020	10.06	28.06
2021	29.05	14.06
2022	09.05	21.05

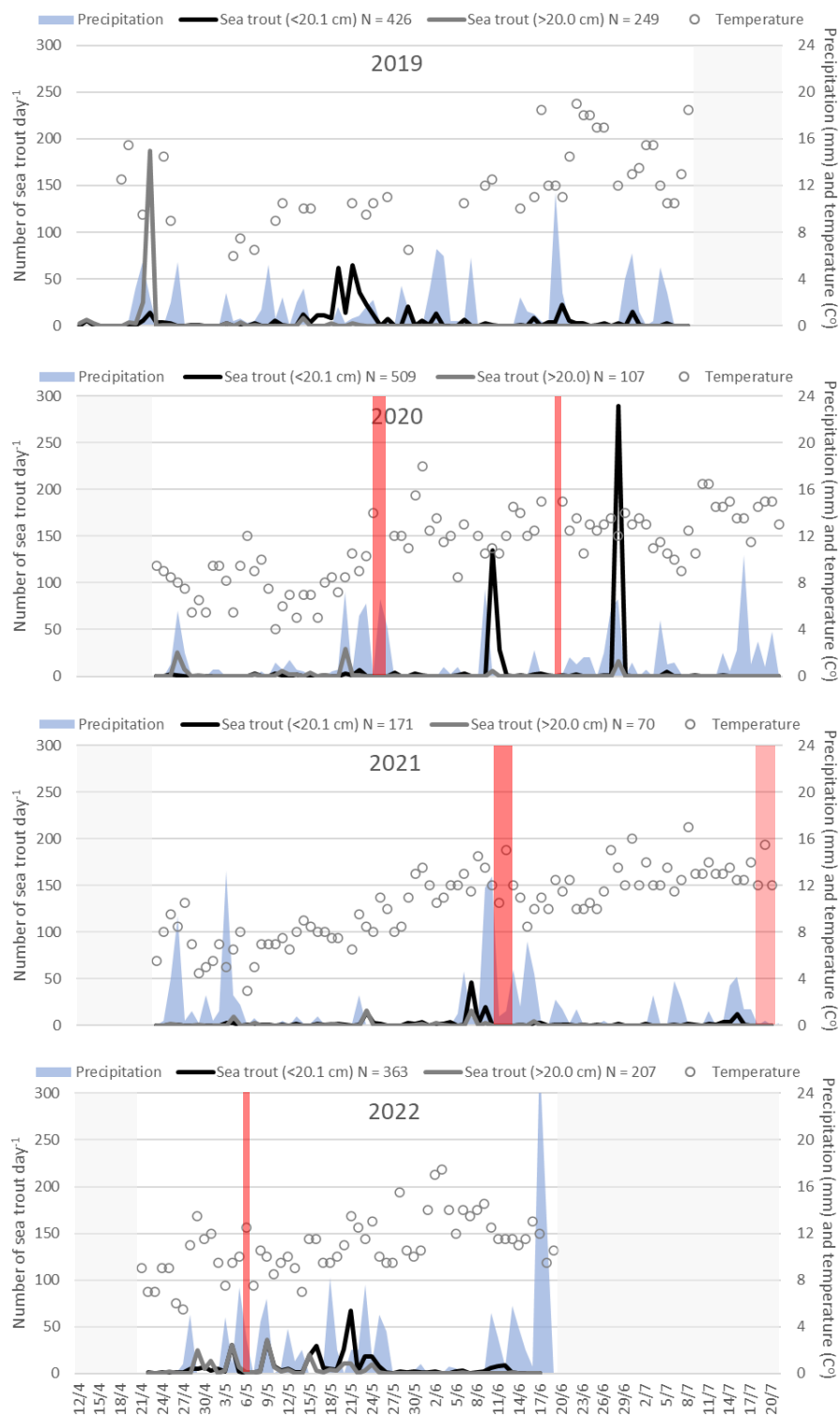

Figure 2. Number of sea trout caught, precipitation (mm) and temperature (C°) per day in 2019-2022. Light grey areas represent periods without sampling. Red areas indicate days when the trap was not sampling due to high precipitation levels (dark) or upstream migrating sea trout (light). There were days in 2019 when the trap was not sampling, but unfortunately the exact dates have not been registered.



Overall, the condition factor of the sea trout sampled in the trap in 2022 was significantly lower compared to 2019 and 2020 (t -test, $p < 0.0001$), but somewhat higher than in 2021 (t -test, $p < 0.0001$) (Figure 3). The same pattern emerged when the annual difference was compared in the small size group (< 20.1 cm), but here there was no significant difference between 2022 and 2021. Regarding the larger specimens (> 20.0 cm), the sea trout sampled in 2022 were in a significantly better condition compared to the sea trout sampled in 2021 and 2019 (t -test, $p = 0.0009$), but in a condition similar to the sea trout sampled in 2020 (Figure 3).

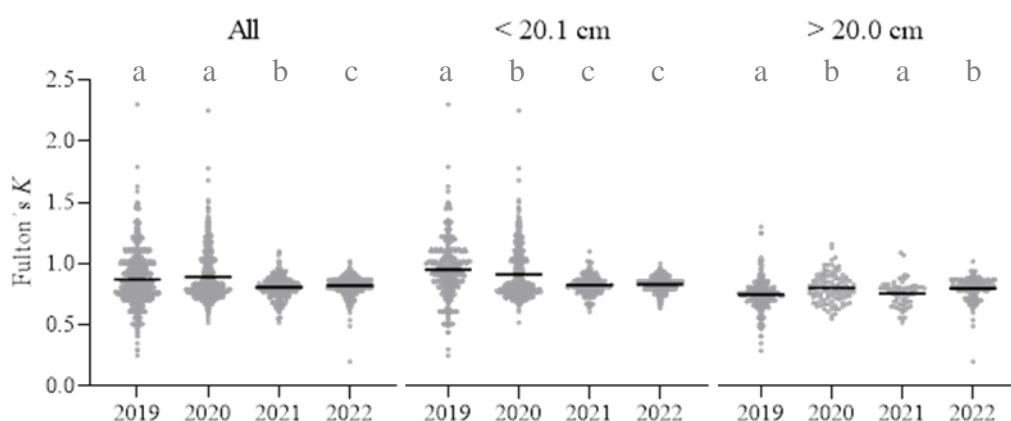

Figure 3. Average condition factor (Fulton's K) of all sea trout sampled in the trap from 2019 to 2022, as well as in the small (< 20.1 cm) and large (> 20 cm) size groups. Different letters indicate significant statistical difference (t -test, $p < 0.05$).

Project 2: The condition of sea trout at sea

Material and methods

Scale and other information on sea trout caught at sea is sampled in two ways, i.e., 1) sampling by gillnets (5 m width, 2 m height and 20 mm mesh size), and 2) by anglers donating sea trout scales and information such as length, weight and sea lice counts by using special envelopes developed for the purpose (Figure 4), in return participating in an annual drawing toss for 10,000 DKR.



Figure 4. The envelopes developed for the anglers to donate sea trout scale and other information.



The gillnets were deployed at a $\sim 90^\circ$ angle to shore, and checked at least once every 30 minutes. To minimize the influence of salinity on the sea lice numbers, the nets were set in $>32\text{‰}$ waters (measured using YSI Pro30). After sampling, the fish were killed in an overdose of Benzocaine (Tjaldurs Apotek, Tórshavn) and transported to shore. On land the sea lice were counted and grouped into 1) adult female *Lepeophtheirus salmonis*, 2) adult male + preadult *L. salmonis*, 3) *Caligus elongatus*, and 4) chalimus. Due to the large numbers of chalimus on the sea trout sampled in Øravík in 2021, and the significantly higher number of sea lice pertaining thereto, we sampled chalimus for PCR species identification at both sampling sites in 2022, i.e., 50 specimens in Vágur and 8 specimens in Fámjin. The sea trout were weighed to the nearest 0.1 g and length measured to the nearest 0.1 cm. Scale was sampled from each fish and stored for later age and growth determination. Lastly, the sea trout were gutted and the stomach content analysed.

In 2022 the gillnet sampling was conducted on June 20th to 23rd, approximately one week earlier than in 2021. And as in 2021, two locations on the southernmost island were selected, one representing sea trout close to salmon farming and the other not. The sampling location close to salmon farming was in 2021 close to the farming site A-15 Froðba, however, in 2022 this site was almost empty when the samplings were to be conducted, and thus another site was selected and sampled, i.e., Vágur, which is close to the farming site A-19 Lopra (Figure 5). 28 sea trout were sampled in Fámjin and 33 sea trout were sampled in Vágur, and thus we unfortunately exceeded the total annual allowance of 50 sea trout per year by 11 sea trout.



Figure 5. Locations of the gillnet sampling sites. Fámjin (2021 and 2022, blue star), Froðba (2021, yellow star), and Vágur (2022, red star).

Results

Scale and/or other information on sea trout caught with gillnets or by anglers has now been sampled from 778 specimens in total (Table 2).

Table 2. Number of sea trout caught at sea by anglers and gillnets from 2019 to 2022.

	Anglers	Gillnets	Total
2019	147	32	179
2020	168	46	214
2021	127	50	177
2022	147	61	208
Total	589	189	778

The sampling from 2019 to 2022 was seasonally unevenly distributed, i.e., the majority is from June to August, while the data from the remaining months is more sporadic. When the sea trout are grouped into length categories, the smallest (< 20 cm) first appears in May and disappears in



September. No sea trout larger than 49.9 cm have to date been reported in the months September to November (Figure 6).

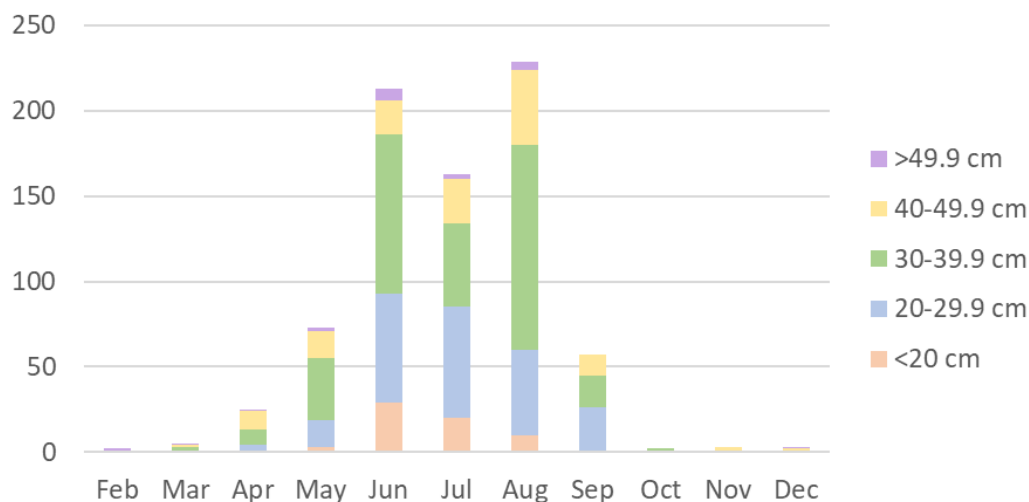

Figure 6. Number of sea trout caught at sea by anglers and gillnets in 2019-2022 divided into length groups.

On average the sea trout sampled at sea in 2022 weighed 367 g (max 3000 g; min 34 g) and were 31.3 cm in length (max 63.0 cm; min 15.5 cm). In 2022 the average sea trout condition factor (Fulton's *K*) was 0.95 (max 1.57; min 0.68). Although somewhat shorter than in 2020, the sea trout sampled in 2022 were overall in a condition comparable to 2020, which was better than in 2019 and 2021 (Table 3).

Table 3. Length, weight, and condition factor (Fulton's *K*) of the total catch of sea trout, sea trout caught by anglers and sea trout caught with gillnets, respectively, in the years 2019 to 2022. Different superscript letters indicate significant difference (*t*-test, $p < 0.05$).

	Year	Length (cm)			Weight (g)			Fulton's <i>K</i>		
		Average	Min	Max	Average	Min	Max	Average	Min	Max
Total	2019	32.8 ^{ab}	17	58	505 ^a	55	2000	0.88 ^a	0.39	1.51
	2020	34.1 ^a	17.2	57	397 ^b	17	2300	0.93 ^b	0.18	1.44
	2021	30.6 ^c	17	56	345 ^b	36	1500	0.83 ^a	0.42	2.23
	2022	31.3 ^{bc}	15.5	63	367 ^b	34	3000	0.95 ^b	0.68	1.57
Anglers	2019	33.4 ^{ab}	17	56	578 ^a	150	2000	0.87 ^a	0.39	1.51
	2020	35.2 ^a	18	57	424 ^b	17	2300	0.93 ^a	0.18	1.44
	2021	30.7 ^c	17	56	424 ^b	58	1500	0.88 ^a	0.45	1.25
	2022	33.6 ^b	18	63	476 ^b	77	3000	1.02 ^b	0.68	1.57
Gillnets	2019	30.1 ^a	17.1	58	333 ^a	55	1820	0.89 ^a	0.56	1.24
	2020	30.0 ^a	17.2	49.4	329 ^a	45	951	0.92 ^a	0.65	1.17
	2021	30.4 ^a	17.2	50.5	234 ^{ab}	36	943	0.76 ^b	0.42	2.23
	2022	25.7 ^b	15.5	53.9	187 ^b	34	1400	0.83 ^b	0.73	0.95



Scale of the 208 sea trout sampled in 2022 were analysed, but of which, 14 were not readable. The age distribution of the sea trout examined was 49 2-years-old, 93 3-years-old, 34 4-years-old, 13 5-years-old and five 6-years-old. Unlike 2019 and 2020, and like 2021, no 7-years-old specimens were sampled in 2022 (Figure 7).

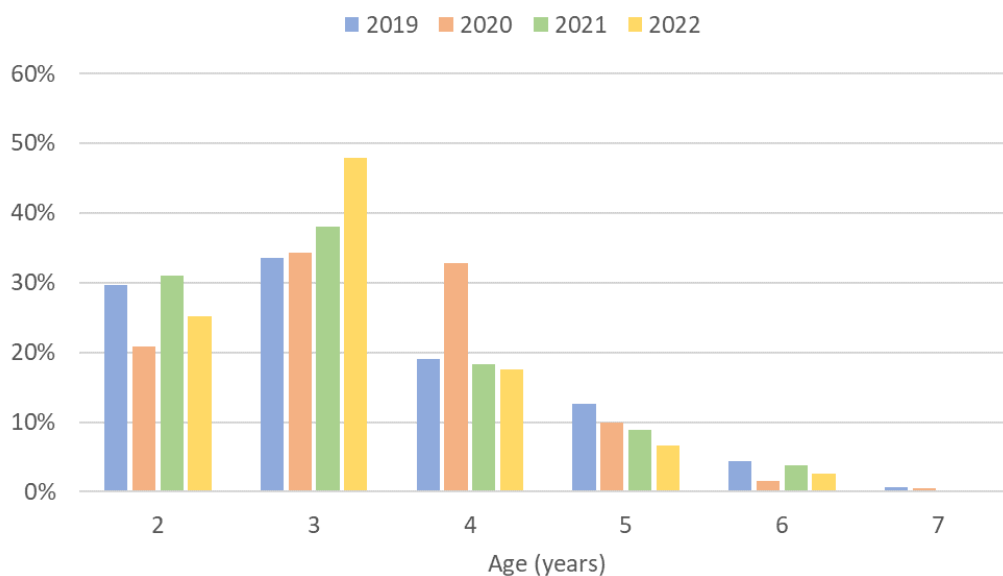

Figure 7. Age distribution of the sea trout sampled in 2019-2022.

The average age of the sea trout sampled in 2022 was 3.13 years, which was somewhat lower than in previous years, i.e., 3.30 years (2019), 3.39 (2020) and 3.16 (2021), but only significantly different from the average age in 2020 (t -test, $p < 0.05$).

The sea trout sampled in 2022 had on average spent 2.36 years in freshwater before migrating to sea for the first time, and had the average sea age of 0.77 years, which differed significantly from the time spent in freshwater prior to the first seaward migration of the sea trout sampled in 2020, and from the sea age of the sea trout sampled in 2019 and 2020 (Figure 8).

Comparison of the length-at-age of sea trout that had spent two or three years in freshwater before migrating to sea for the first time again showed that the average length-at-age was significantly different between the two, i.e., the sea trout that had spent two years in freshwater before migrating to sea, had a significantly greater length. However, and probably due to a too small sample size, i.e., five samples regarding the two years in freshwater specimens, and ten samples regarding the three years in freshwater specimens, the 6-years-old did not show a significant difference in length (Figure 9).

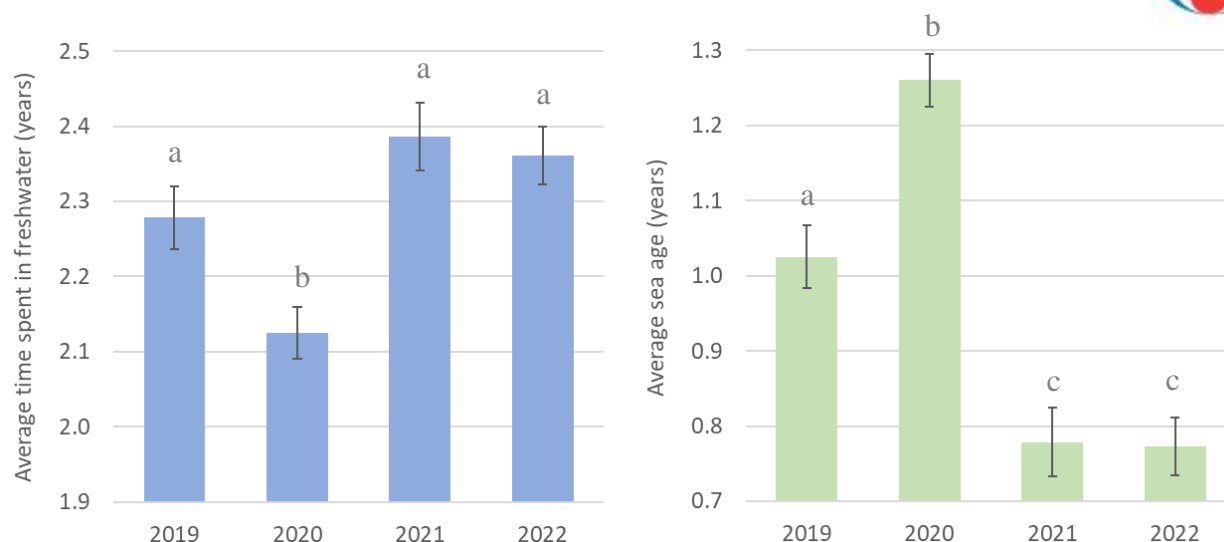

Figure 8. The average time spent in freshwater before migrating to sea for the first time (left) and the average sea age (right). Vertical bars indicate standard error. Different letters indicate statistical difference (t -test, $p < 0.05$).

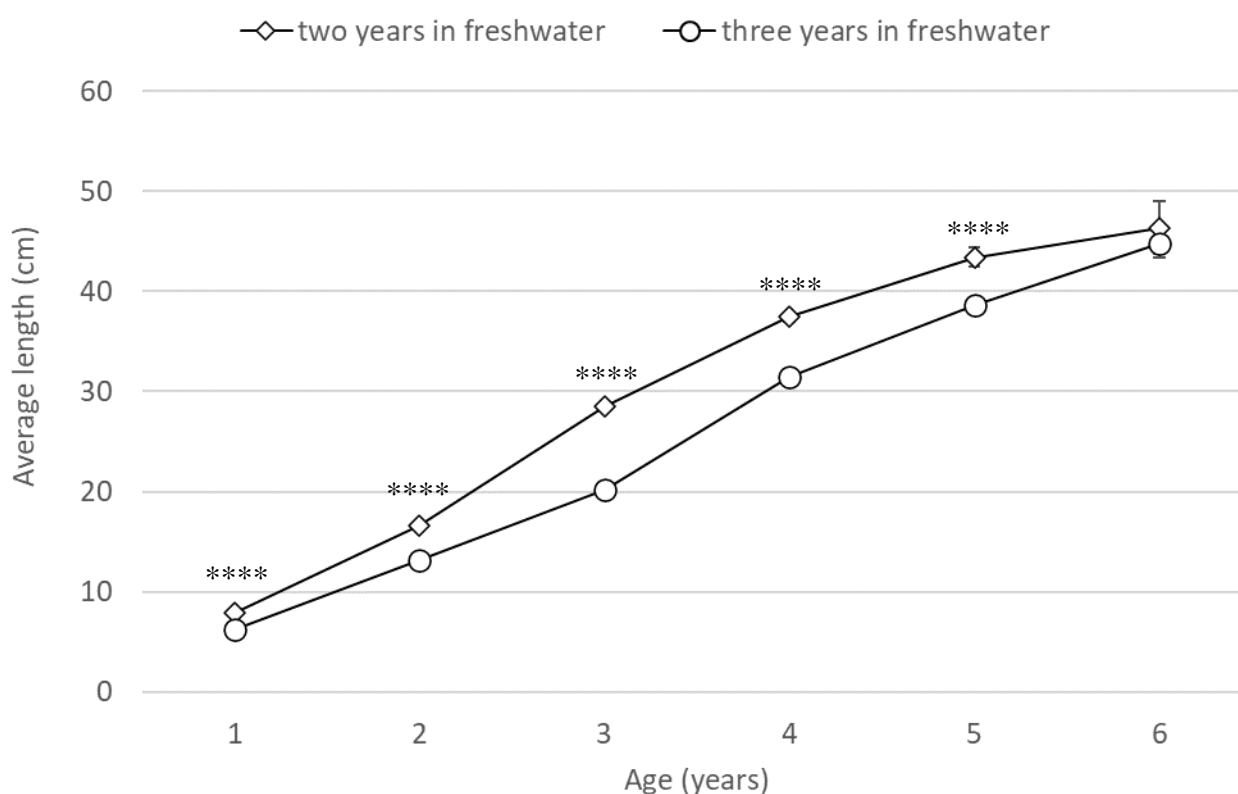

Figure 9. Length-at-age of sea trout migrating to sea after two (diamonds) and three (circles) years in freshwater. Vertical bars indicate standard error. **** represents significant difference of $p < 0.0001$ (t -test).



A comparison of the growth in the third year of specimens that had spent two years in freshwater before migrating to sea, showed a significant difference (t -test, $p < 0.05$), i.e., the sea trout that migrated to sea for the first time in 2018 (18/19) and 2019 (19/20) had a significant better growth compared to those who migrated to sea for the first time in 2021 (21/22) (Figure 10).

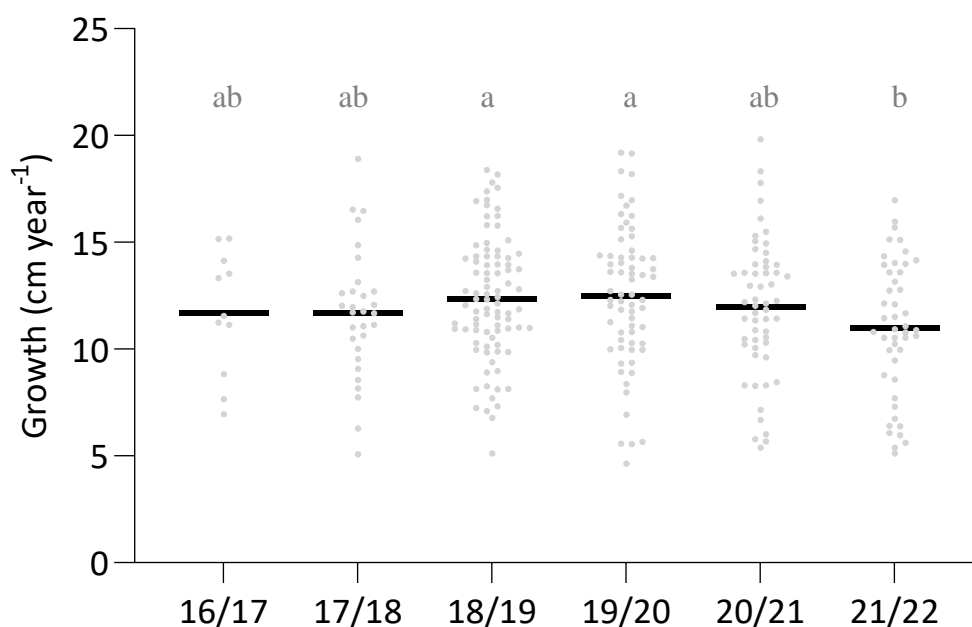

Figure 10. Annual average of the growth (dark horizontal lines) the first year at sea of 3-years-old specimens that had spent two years in freshwater before migrating to sea. Different letters indicate statistical difference (t -test, $p < 0.05$).

The results from the sea lice counts conducted by anglers and the trained gillnet staff are most likely not comparable and will thus not be compared, but presented separately. Sea trout caught in rivers and lakes are excluded from the analysis regarding sea lice, as freshwater might have a delousing effect.

The sea trout caught by anglers in 2022 had on average 4.1 sea lice, a sea lice prevalence of 66% and an average condition factor of 1.03 (Figure 11). Although appearing to be lower, no significant difference was found between the average sea lice load in 2022 and the previously sampled years (One-way Anova, $p = 0.431$). Opposite, the prevalence of sea lice appeared to be higher in 2022 compared to the previously sampled years, however, although close, the difference was not significant (Chi-square, $p = 0.056$). On the contrary, a significant annual difference was found regarding the condition factor (One-way Anova, $p < 0.0001$), i.e., the sea trout caught by anglers were in 2020 and 2022 in a better condition compared to the sea trout caught in 2019 and 2021 (t -test, $p < 0.05$) (Figure 11).

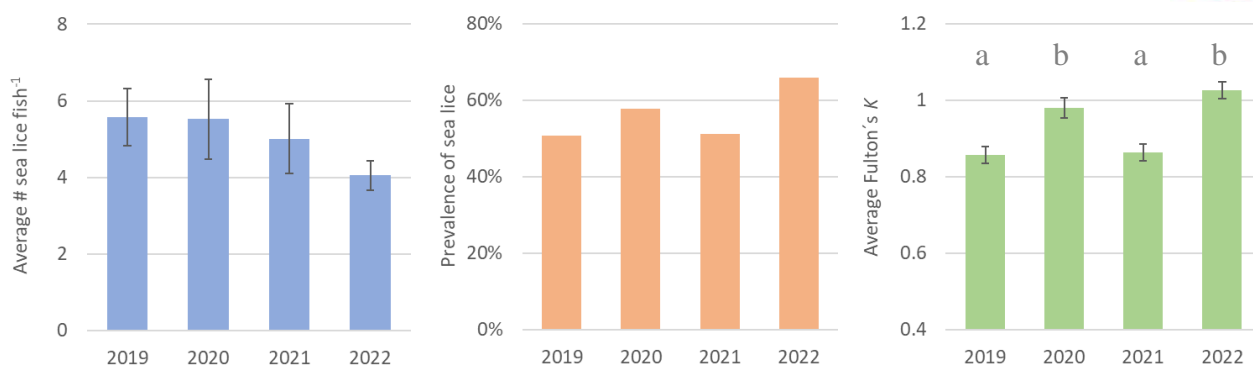

Figure 11. Annual variations in the average number of sea lice fish⁻¹, prevalence of sea lice and average condition factor (Fulton's K) of the sea trout caught by anglers. Vertical bars indicate standard error. Different letters indicate statistical difference (t-test, $p < 0.05$).

The monthly variation in the average number of sea lice fish⁻¹, prevalence of sea lice and average condition factor (Fulton's K) was in 2022 very similar to what has been observed in previously sampled years (Figure 12). Only September 2022 differed from September in previously sampled years regarding sea lice load, sea lice prevalence and condition factor. The data on sea trout in September 2022 were all from the same location and the same angler, which might bias the results.

Based on the salmon lice index presented by Taranger *et al.* (2012) on how to estimate the influence of salmon farming on wild salmonid stocks, we grouped the lice load of sea trout larger than 150 g into five categories, i.e., <0.025 , $0.025-0.05$, $0.05-0.10$, $0.10-0.15$ and >0.15 lice gram sea trout⁻¹, which represents 0%, 20%, 50%, 75% and 100% expected mortality, respectively. Since the sea lice data probably not are comparable, the results are presented as the total sea lice load on sea trout caught by anglers (left panel), the total sea lice load on sea trout caught with gillnets (mid panel), and the salmon lice (*L. salmonis* (chalimus excluded)) load on sea trout caught with gillnets (right panel) (Figure 13). In general, the sea lice load categories representing 0% and 20% expected mortality were dominating, and as in 2021, the potential influence of lice diminished drastically when the chalimus stages were excluded (Figure 13, right panel).

Taranger *et al.* (2012) also presented a salmon lice index for sea trout smolts (<150 g), however, since only data from four sea trout less than 150 g have been received from anglers, the results presented from this size group are only from the gillnet samplings. Compared to previous years, fewer of the sea trout <150 g were in 2022 grouped as having lice loads estimated to result in mortalities (left panel). Again, the ratio of estimated mortality diminished when the chalimus stages were excluded (right panel) (Figure 14).

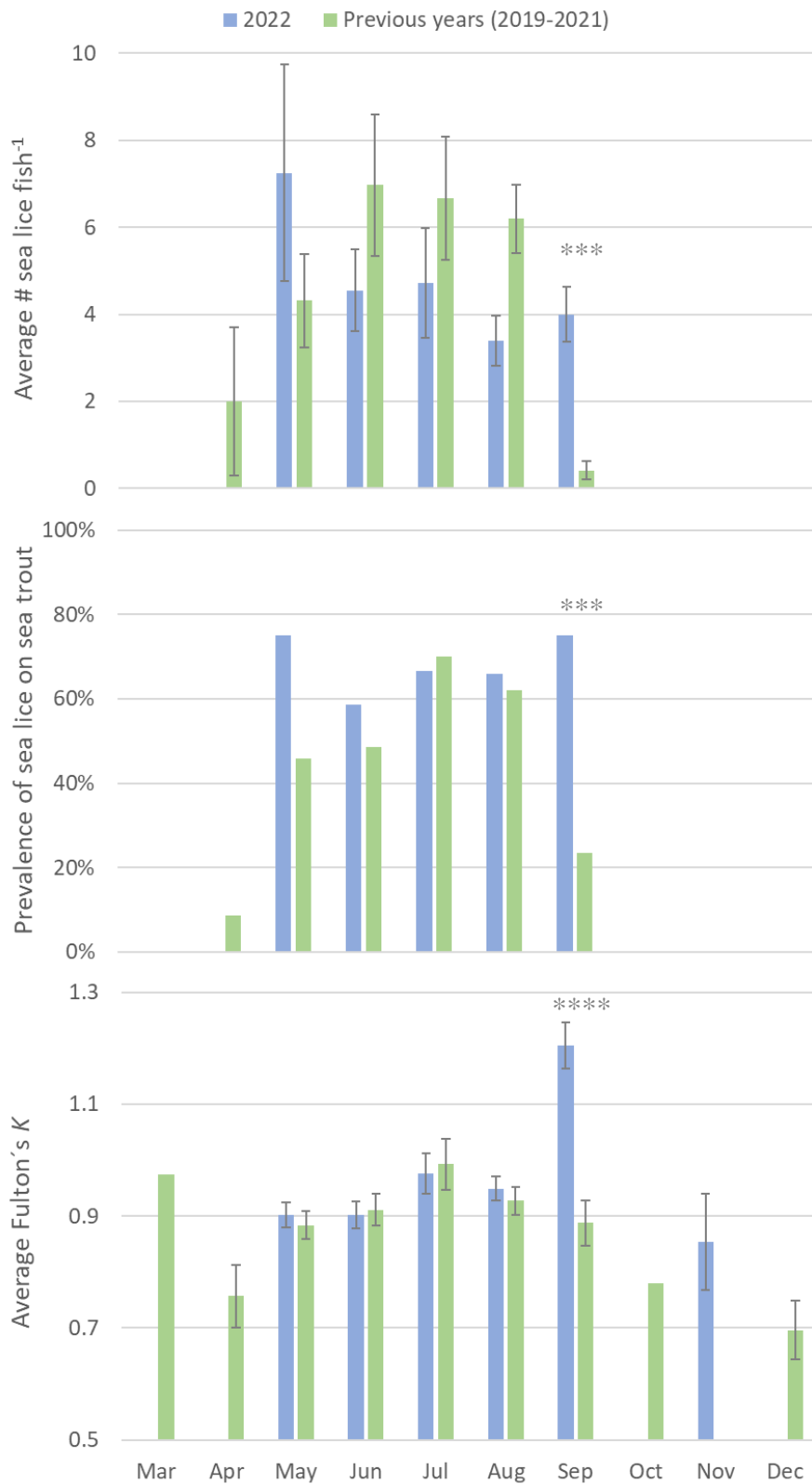

Figure 12. Monthly variations in the average number of sea lice fish⁻¹, prevalence of sea lice and average condition factor (Fulton's K) of the sea trout caught by anglers. Vertical bars indicate standard error. *** and **** represents significant difference of $p < 0.001$ and $p < 0.0001$, respectively (t -test and chi-square test).

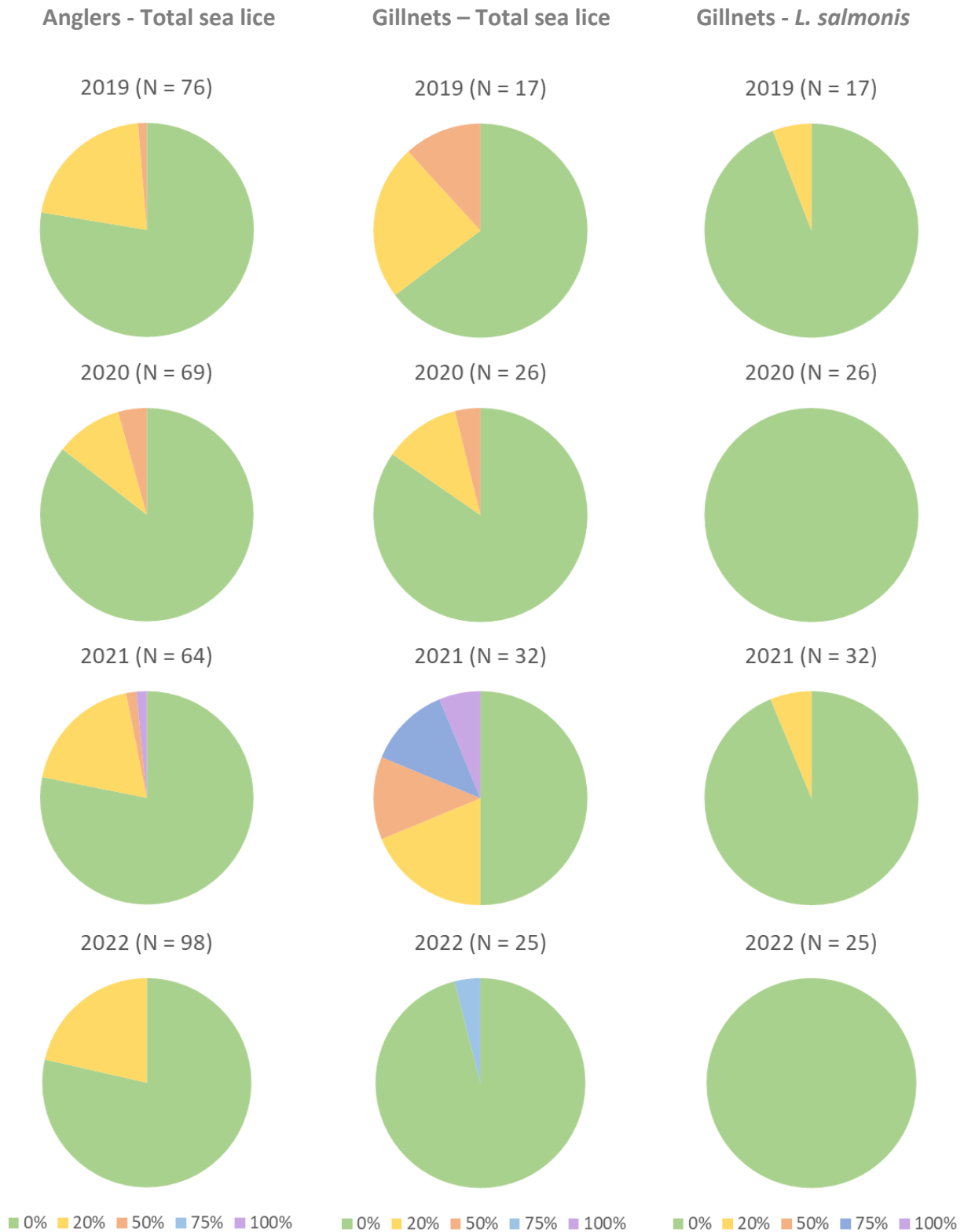

Figure 13. Proportion of sea trout (>150 g) with salmon lice loads estimated to result in 0%, 20%, 50%, 75% and 100% mortalities.

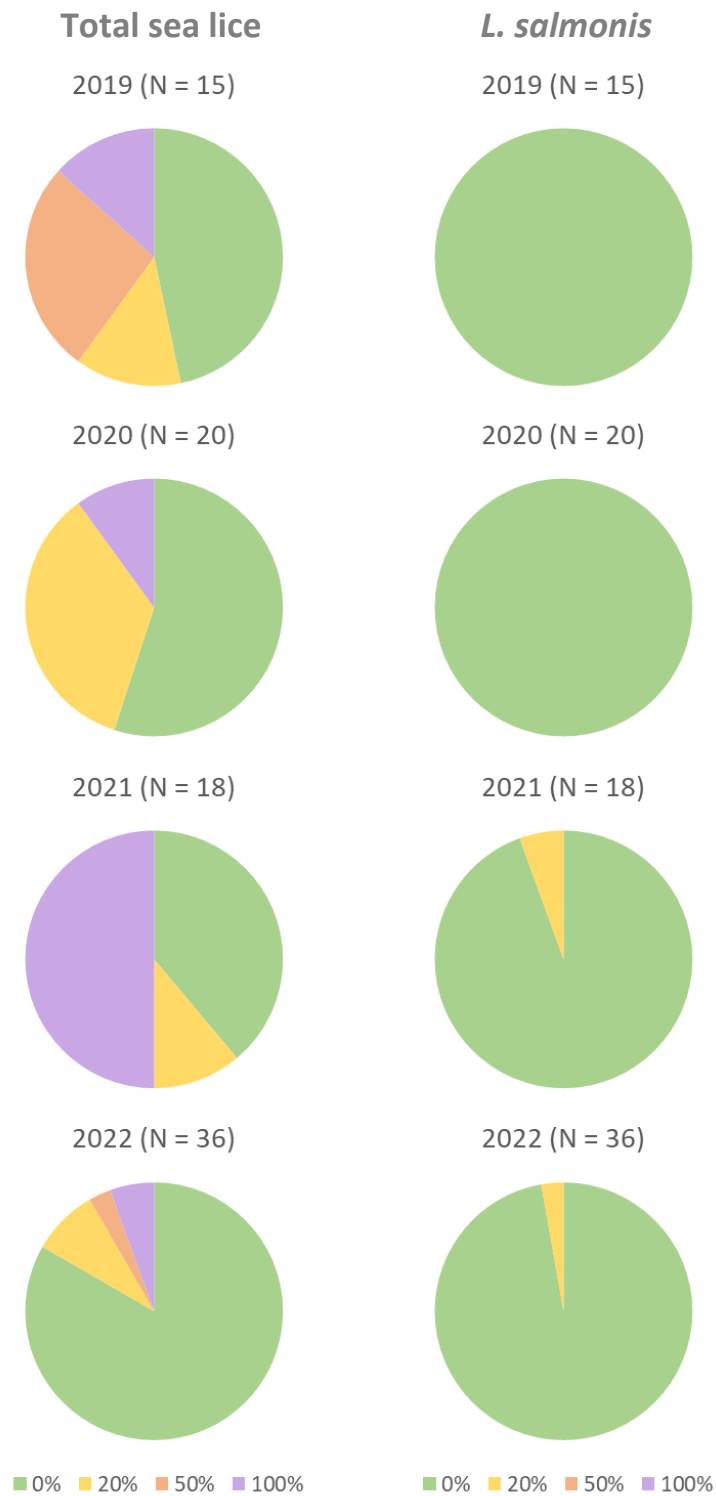

Figure 14. Proportion of sea trout smolt (<150 g) with salmon lice loads estimated to result in 0%, 20%, 50% and 100% mortalities.



The results from the sampling two sampling sites where one site represented sea trout close to salmon farming (Froðba 2021 and Vágur 2022) and the other not (Fámjin), showed that the sea trout at both sites in 2022 had approximately the same average age, i.e., ~2.9 years in Fámjin and ~2.8 in Vágur, with the same minimum age, i.e., 2 years, but with a maximum age of 6 and 5 years, respectively. However, the sea trout sampled in Vágur 2022 was significantly younger than the sea trout sampled at both sites in 2021 (Figure 15a).

A significant difference was observed in the average condition factor between years and sites, i.e., in both 2021 and 2022, the sea trout sampled in Fámjin (far from salmon farming), had a significantly higher condition factor compared to the sea trout sampled closer to salmon farming, i.e., Øravík and Vágur. Furthermore, the sea trout sampled in Vágur 2022 was in a significantly better condition compared to the sea trout sampled in Øravík 2021, while the sea trout sampled in Fámjin was in a significantly better condition in 2021 compared to 2022 (Figure 15b). Unlike in 2021, there was in 2022 no significant difference in the number of sea lice per sea trout between the sites representing sea trout close to and far from salmon farming (Figure 15c), which also was the case when the number of salmon lice per sea trout was compared between years and sites (Figure 15d).

By grouping the sea lice load of the sea trout sampled at the two sites into the groups of different estimated mortalities according to Taranger *et al.* (2012), a large difference was observed between sites and years, i.e., in Øravík 2021 and Vágur 2022 the estimated mortality due to the sea lice load was ~45% and 11%, respectively, while it was between 0% (2022) and 2% (2021) in Fámjin (Figure 16). However, if the same groupings were performed without the chalimus stages, the estimated mortality was between 0% and 2% at all sites (Figure 17).

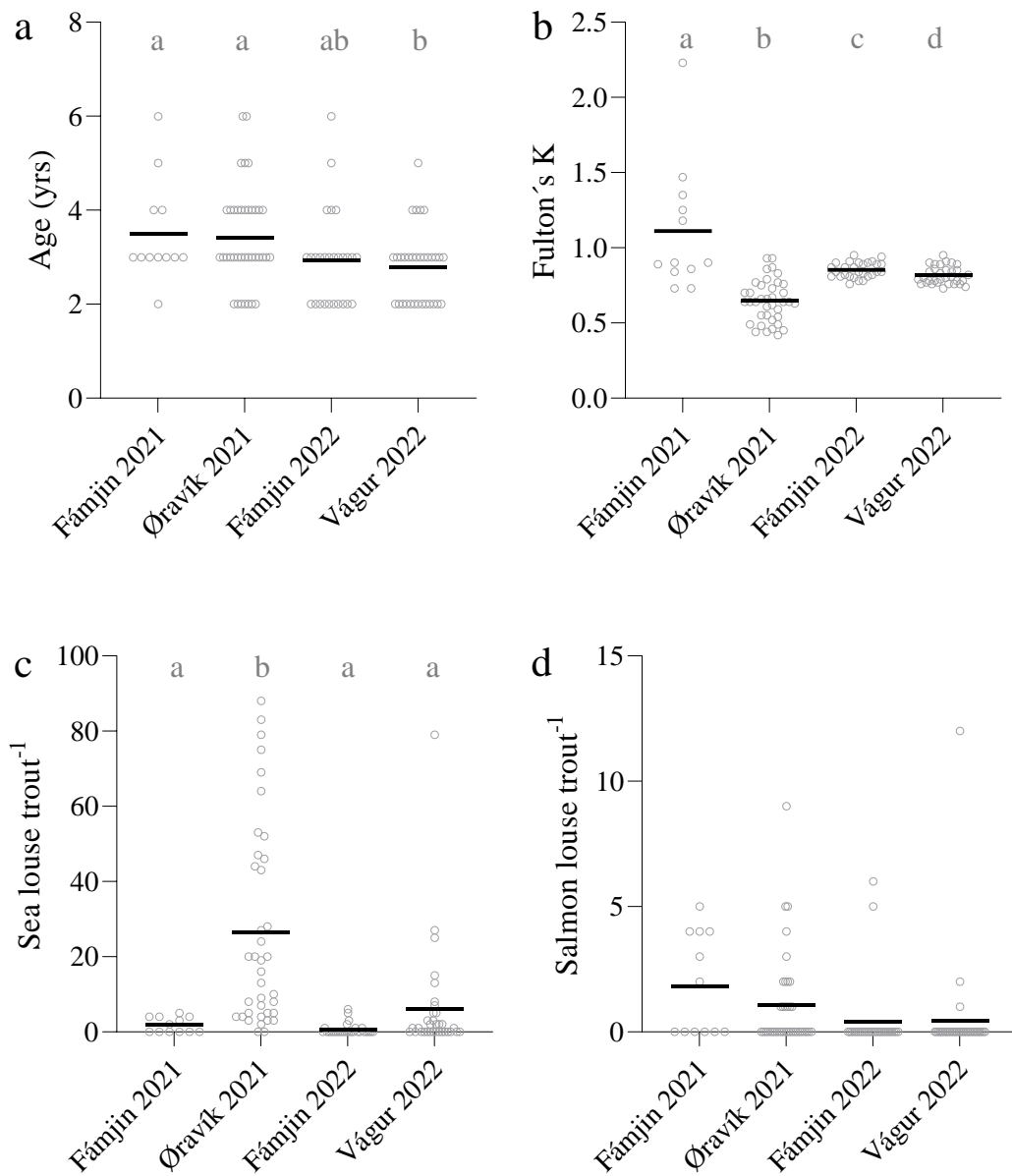

Figure 15. Average age, condition factor (Fulton's K), sea lice number and number of salmon lice (*L. salmonis*) of sea trout sampled in Fámjin and Øravík/Vágur in 2021 and 2022 (vertical lines). Different letters indicate significant statistical difference (t -test).

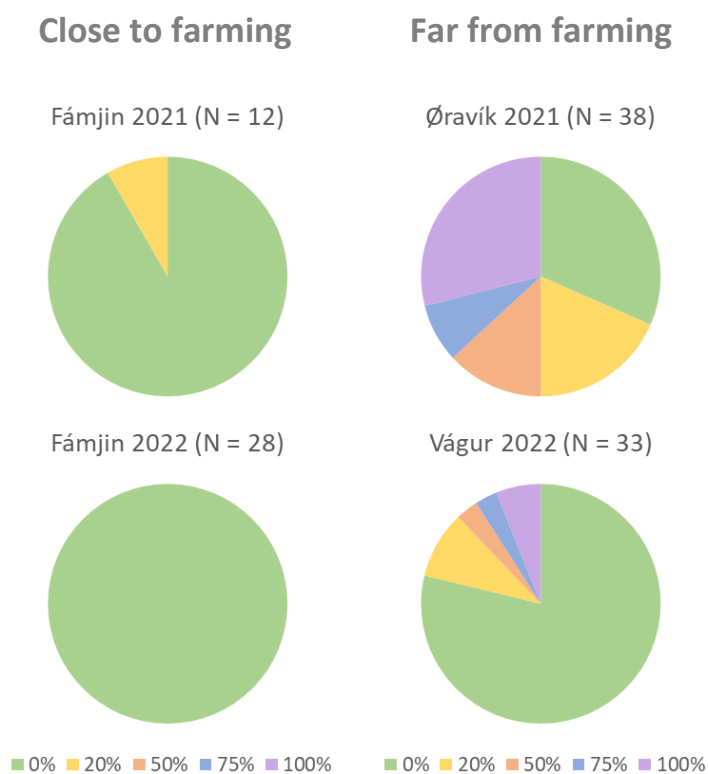

Figure 16. Proportion of sea trout sampled in Fámjin, Øravík and Vágur with salmon lice loads estimated to result in 0%, 20%, 50%, 75% and 100% mortalities.

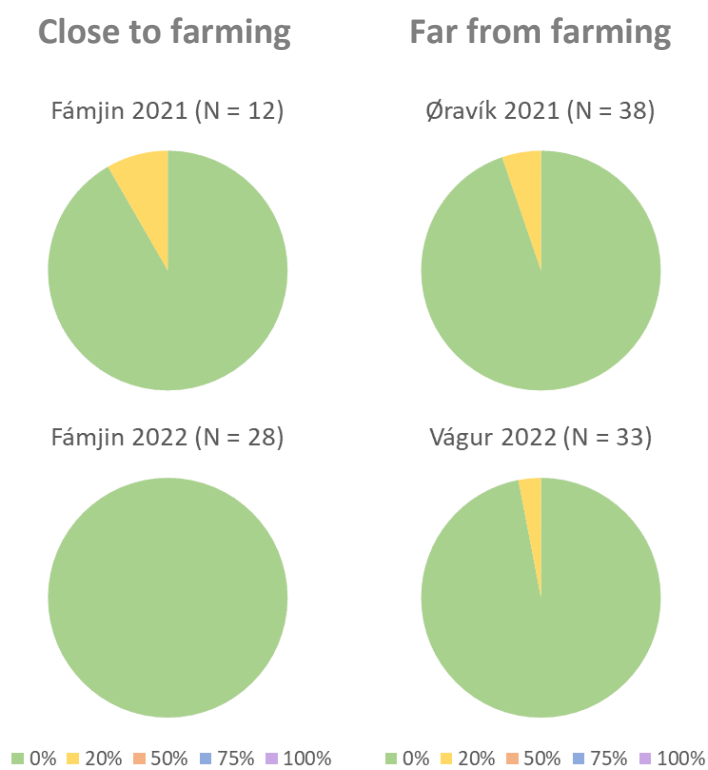

Figure 17. Proportion of sea trout sampled in Fámjin and Øravík with salmon lice loads (chalimus excluded) estimated to result in 0%, 20%, 50%, 75% and 100% mortalities.



Discussion

As in previous years, the seaward migration of sea trout in Sandá in 2022 was concurrent with much precipitation and the subsequent increase in water discharge, and indications were again of temperature dependent migration, i.e., the bulks in migration of likely first-time migrants (< 20.1 cm) occurred when the water temperature had passed 8 C° (Figure 2). Temperature is known to regulate the rate and duration of the smoltification process (Høgåsen 1998, Byrne *et al.* 2004), however, the relative importance of water discharge and temperature as initiators of smolt migration has been shown to vary among years and areas (Hembre *et al.* 2001; Winter *et al.* 2016). Albeit partially overlapping the corresponding period in 2019, the 25%-75% migration period in 2022 was the earliest recorded to date (Table 1). Overall, the 25%-75% migration window has ranged from mid-May to late June in the four-year period the project has lasted (Table 1), which is in the late category compared to other European rivers (Thorstad *et al.* 2016).

In 2021 the number of sea trout entering the trap was much lower than in the two previous sampling years. In 2022 the number raised again, to a level similar to 2019 and 2020. It was speculated, that the drop in number of juvenile sea trout in 2021, might have been due to youngsters disturbing the trap or due to the low condition factor of the juvenile sea trout (< 20.1 cm) that year, however, youngsters were also disturbing the trap in 2022 and the condition factor of the juvenile sea trout in 2022 was not significantly different from the condition factor of the juvenile sea trout in 2021 (Figure 3).

The results of the length distribution of sea trout sampled at sea was in concert with the findings in the trap, i.e., the smallest sea trout (< 20.1 cm, most likely first-time migrators) initially appeared in May and disappeared in August, probably due to growing out of the smallest category.

Furthermore, no large specimens (> 49.9 cm) have to date been sampled from September to November, indicating a spawning period similar to that in northern Norway (Figure 6) (Jensen and Rikardsen 2008).

Similar to the results from the trap (Figure 3, > 20.0 cm), the overall state of the sea trout caught at sea indicated that the specimens in 2022 were in a somewhat better condition compared to in 2019 and 2021 (Table 3). Indicating, that the annual variation in sea trout condition in the river and at sea follow the same trend, and that the condition in which the sea trout enters the sea, might have a prolonged effect.

By having the largest cohort of 3-years-old to date, the age distribution in 2022 differed from the previous sampling years (Figure 7). Similar to 2021, and despite of having spent on average more time in freshwater prior to migrating to sea, the average age in 2022 was lower compared to 2020



due to the lower average sea age (Figure 8).

Comparison of the length-at-age of sea trout that had spent two or three years in freshwater before migrating to sea has previously shown that the average length-at-age is significantly higher for the two-years-in-freshwater cohort, emphasising the enhanced growth rate at sea, as well as indicating that size might be an initiator of seaward smolt migration (Figure 9).

A significantly lower growth rate was observed in the first year at sea in the cohort that migrated to sea in 2021 after two years in freshwater compared to the cohorts migrating to sea for the first time in 2018 and 2019 (Figure 10). This might indicate different, and at times less favourable, conditions at sea between years. Two aspects plausible to influence the growth of sea trout at sea negatively, are lack of food and ectoparasites. A strong correlation between primary production and higher trophic levels, e.g., sandeel, on the Faroe shelf has been well documented (e.g., Gaard *et al.* 2002, Eliassen *et al.* 2011), and measurements of the concentration of Chlorophyll *a* on the Faroe shelf, conducted by the Faroe Marine Research Institute, shows that the concentrations were high in e.g., 2018, 2019 and 2022, while they were exceptionally low in 2021 (Figure 18).

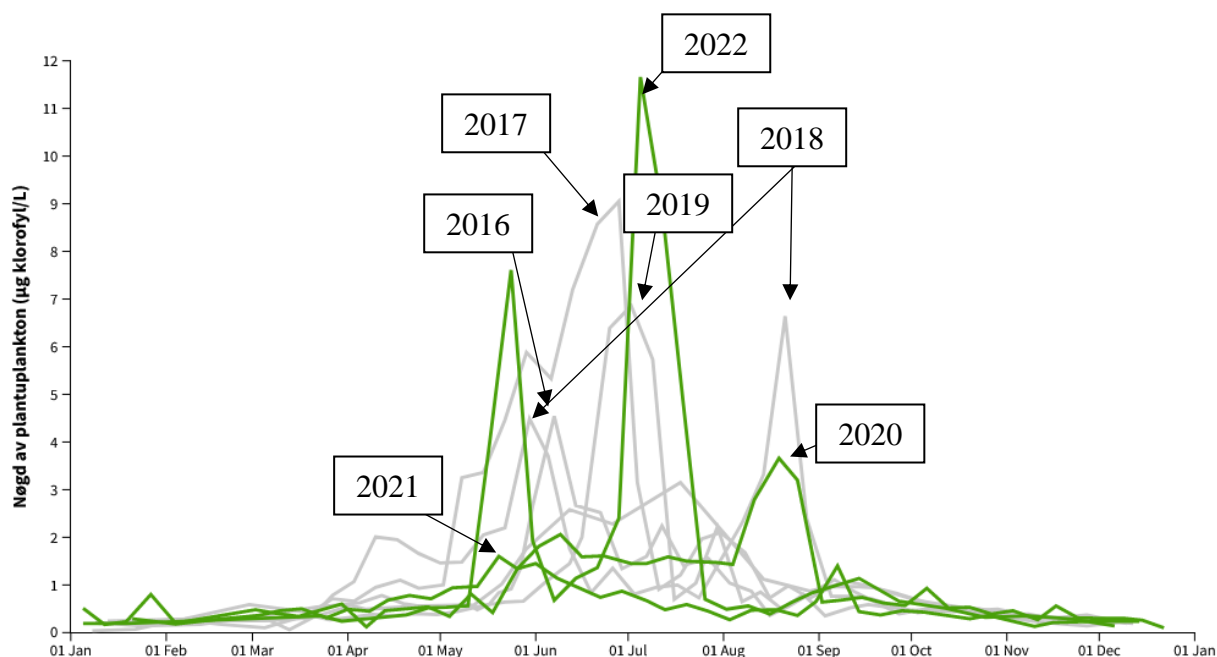

Figure 18. Chlorophyll *a* concentration on the Faroe shelf in the years from 2016 to 2022. Source www.hav.fo.



In late 2017 the number of adult female *L. salmonis* in the Faroese salmon farming industry became publicly available, and similar to the primary production, the years 2018, 2019 and 2022 were more favourable for the sea trout at sea (Figure 19).

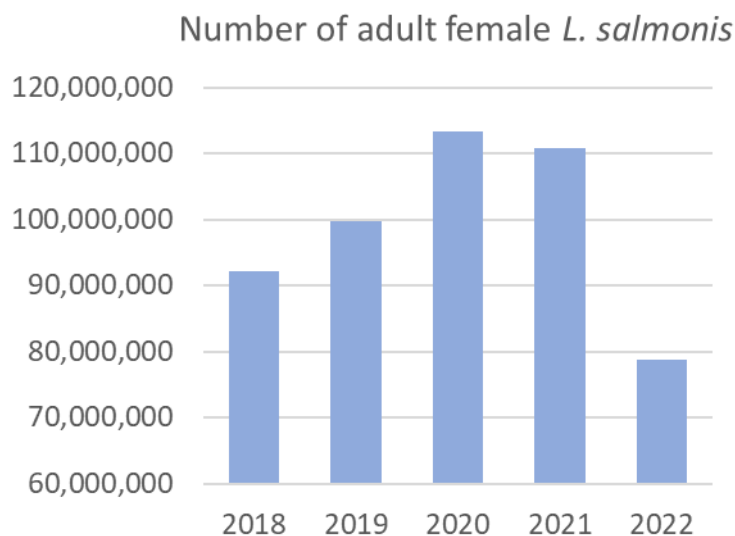

Figure 19. Total number of adult female *L. salmonis* in the Faroese salmon farming industry in the years 2018 to 2021. Source www.hfs.fo

However, no significant difference could be found between the years regarding sea lice load and sea lice prevalence, nevertheless, the condition in 2022 was significantly higher than in 2019 and 2021 (Table 3 and Figure 11), which is in concert with 2022 being a year with high primary production (Figure 18) and relatively few adult female *L. salmonis* (Figure 19). However, the condition of the sea trout sampled in 2020 was not significantly poorer than in 2022 (Table 3), and the average growth was on the high end (Figure 10), indicating that factors other than food and ectoparasites might have an influence on sea trout condition and growth.

Opposite the general trend of a summer peak regarding average number of sea lice and prevalence of sea lice on the sea trout, no such trend was observed in 2022, but still no sea lice have been reported prior to April or after September (Figure 12). Since the abundance of salmon lice in Faroese salmon farming is at its highest in the winter months (Kragesteen *et al.* 2021, www.hfs.fo), the absence of sea lice in this period might indicate delousing in freshwater.

The results from the gillnet sampling in 2021 and 2022, where the locations were selected based on their distance to farmed salmon, showed that in 2021 the sea trout in the vicinity of salmon farming had a significantly higher sea lice load compared to the sea trout sampled far from salmon farming. However, this was not the case in 2022, when no significant difference was to be found (Figure 15). Nevertheless, the sea trout from the two sampling locations were in a significantly different



condition (Fulton's *K*), i.e., the sea trout from the site close to farming were in a poorer state (Figure 15). However, the sea trout caught at the site far from farming were also in a significantly different condition between years, where they were in a better state in 2021, when the primary production was exceptionally low (Figure 18, www.hav.fo), instead of in 2022, when the primary production was exceptionally high, again emphasising the complexity of the system.

C. elongatus has been found to be living on numerous different fish species and it has been proven difficult to determine the causal mechanism or species in the seasonal infestation pattern that is often observed on farmed fish, as correlations between species are likely to be due to derived rather than causal reasons (á Norði *et al.* 2015). Distinguishing between the two most common sea lice species on sea trout, i.e., *L. salmonis* and *C. elongatus*, in the Faroe Islands might thus be of great relevance when grouping the salmon lice load according to Taranger *et al.* 2012, who recommends that the chalimus stages are included (Figure 10, 14, 16 and 17). Therefore, and due to the large number of chalimus on the sea trout sampled in 2021, and the subsequent influence on the results, 58 chalimus were in 2022 sampled from the gillnet catch for PCR species identification. The result was that all were salmon lice, however, and opposite to 2021, when approximately 8% of the sea trout were infested by *C. elongatus*, none of the sea trout sampled with gillnets in 2022 were found to be infested by this species. Thus, and in contrast to 2021, there is no eligible cause to assume that the chalimus found on the sea trout caught with gillnets in 2022 were something else than *L. salmonis*, resulting in an estimated mortality due to salmon lice of ~11% at the site close to salmon farming, or 6.5% in total (Taranger *et al.* 2012, Figure 16).

The results from the sea trout stomachs sampled in 2022 will be included in the next report, as they are part of a BSc project conducted at the University of the Faroe Islands.



References

- á Norði G, Simonsen K, Danielsen E, Eliassen K, Mols-Mortensen A, Christiansen D, Steingrund P, Galbraith M & Patursson Ø (2015) Abundance and distribution of planktonic *Lepeophtheirus salmonis* and *Caligus elongatus* in a fish farming region in the Faroe Islands. *Aquac Environ Interact* 7(1): 15–27
- Byrne CJ, Poole R, Dillane M, Rogan G, Whelan KF (2004) Temporal and environmental influences on the variation in sea trout (*Salmo trutta* L.) smolt migration in the Burrishoole system in the west of Ireland from 1971 to 2000. *Fish Res* 66:85–94
- Eliassen K, Reinert J, Gaard E, Hansen B, Jacobsen JA, Grønkjær P, Christensen JT (2011) Sandeel as a link between primary production and higher trophic levels on the Faroe shelf. *Mar Ecol Prog Ser* 438:185-194
- Gaard E, Hansen B, Olsen B, Reinert J (2002) Ecological feature and recent trends in the physical environment, plankton, fish stocks, and seabirds in the Faroe shelf ecosystem. *Large Marine Ecosystems* 10:245-265
- Hembre B, Arnekleiv JV, L'Abée-Lund JH (2001) Effects of water discharge and temperature on the seaward migration of anadromous brown trout, *Salmo trutta*, smolts. *Ecol Freshw Fish* 10:61–64
- Høgåsen HR (1998) Physiological changes associated with the diadromous migration of salmonids. *Can Spec Publ Fish Aquat Sci* 127:1–128
- Jensen JLA, Rikardsen AH (2008) Do northern riverine anadromous Arctic charr *Salvelinus alpinus* and sea trout *Salmo trutta* overwinter in estuarine and marine waters? *J Fish Biol* 73:1810–1818
- Kragesteen TJ, Simonsen K, Visser AW, Andersen KH (2021) Estimation of external infection pressure and salmon-lice population growth rate in Faroese salmon farms. *Aquacult Environ Interact* 13:21-32
- Taranger GL, Svåsand T, Kvamme BO, Kristiansen TS, Boxaspen KK (2012) Risk assessment of Norwegian aquaculture [Risikovurdering norsk fiskeoppdrett] (In Norwegian). *Fisken og havet, særnummer 2*: 131 pp
- Winter ER, Tummers JS, Aarestrup K, Baktoft H, Lucas MC (2016) Investigating the phenology of seaward migration of juvenile brown trout (*Salmo trutta*) in two European populations. *Hydrobiologia* 775: 139–151